











AJJ-DX1-DTP1

MultiRay.

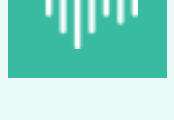
Multi-functional dynamic digital radiography designed to allow integration of digital radiography, fluoroscopy, full-body stitching and pneumoconiosis examination.



HD Dynamic flat panel detector Professional image processing system

-  Large view size at 17x17 inches
-  No distortion with linear detection plane
-  0.8s switch radiography to fluroscopy
-  DFP synchronised exposure
-  9 million pixel for HD
-  iGCR Intelligent ROI gray compensation
-  iTE Intelligent Tissue Equalization
-  iDG Intelligent DeGrid
-  iCED Intelligent Context-Enhancing Denoise
-  iMR Intelligent Metal Recognition
-  iDC Intelligent Dose Control

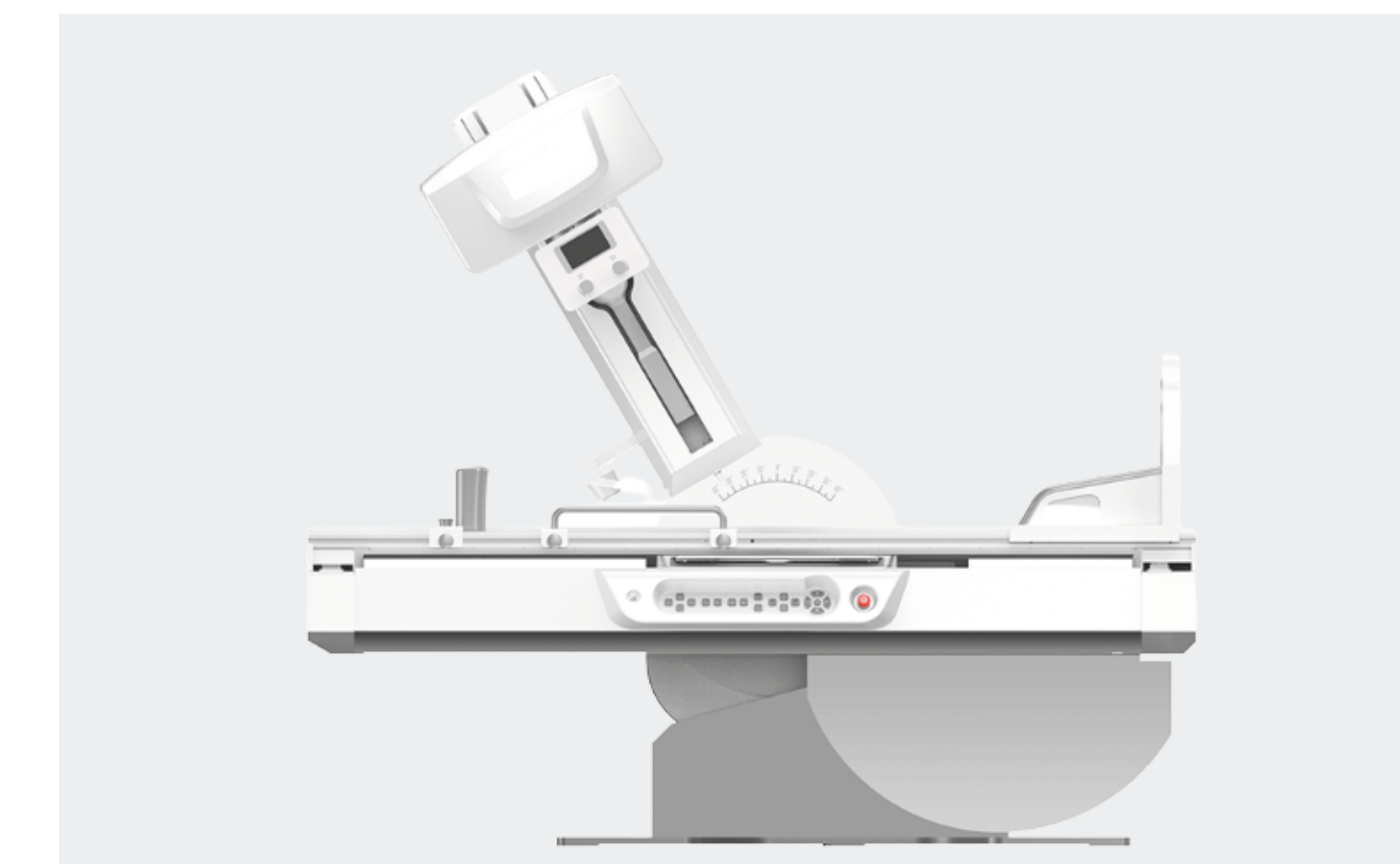

+ -35° ~ 35° multi-angle shooting

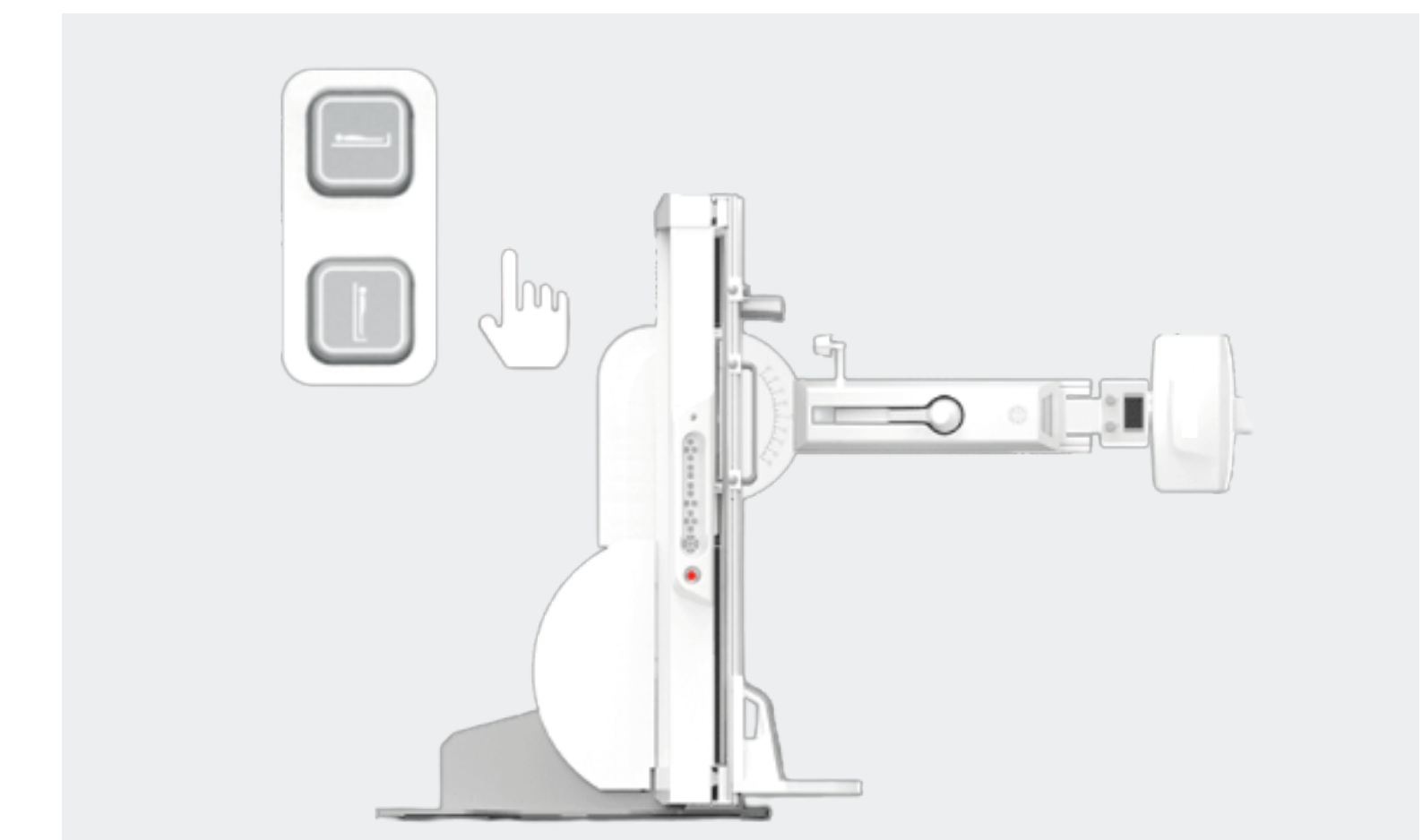

+ One-key switch from chest to bed with side panel for smart lock

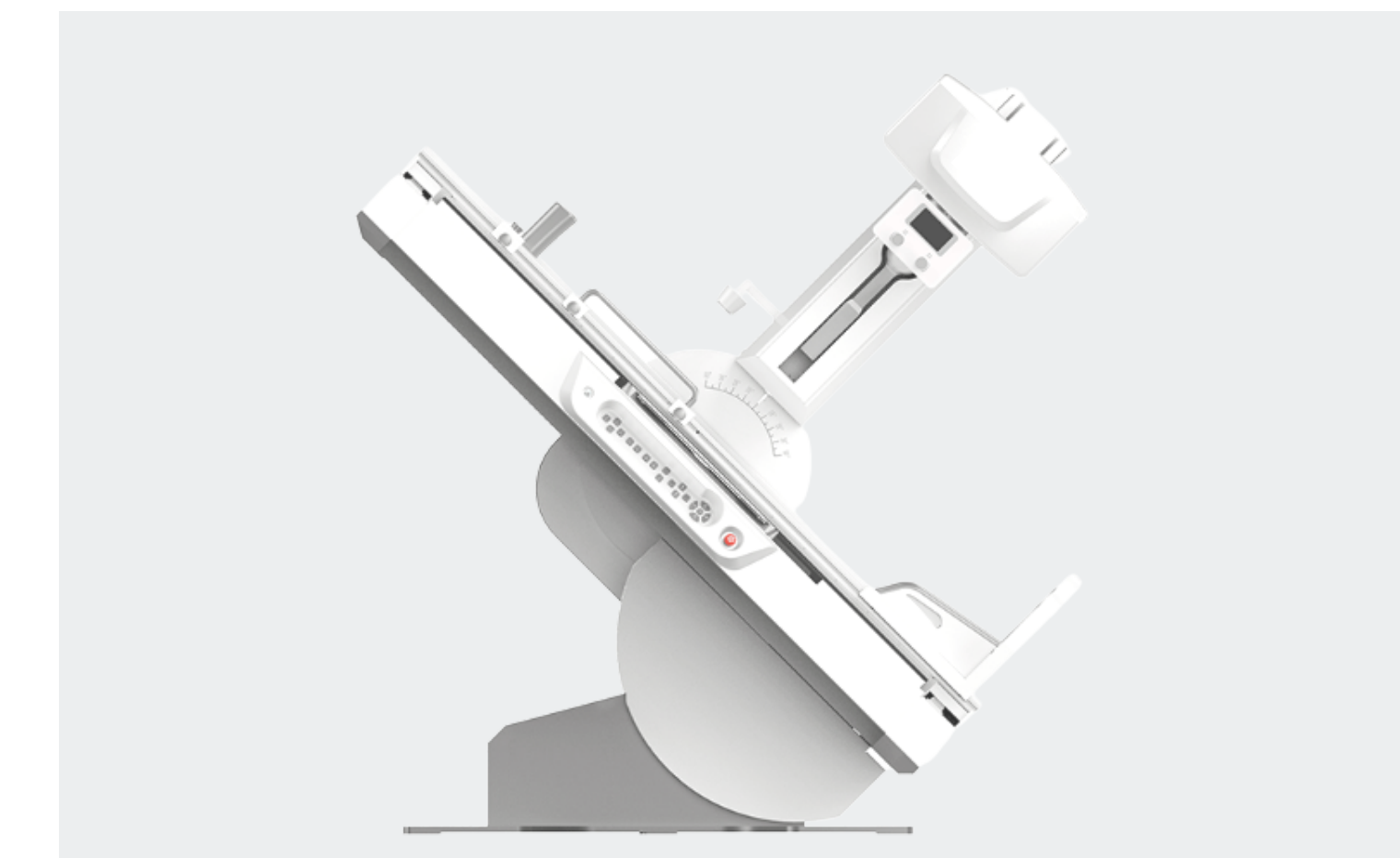

+ SID range of 1 ~ 1.8 meters
-15° ~ 90° large-scale bed rotation



+ Removable grid design



+ Low table top



+ Integrated console design



+ 360° motorized rotating pedal

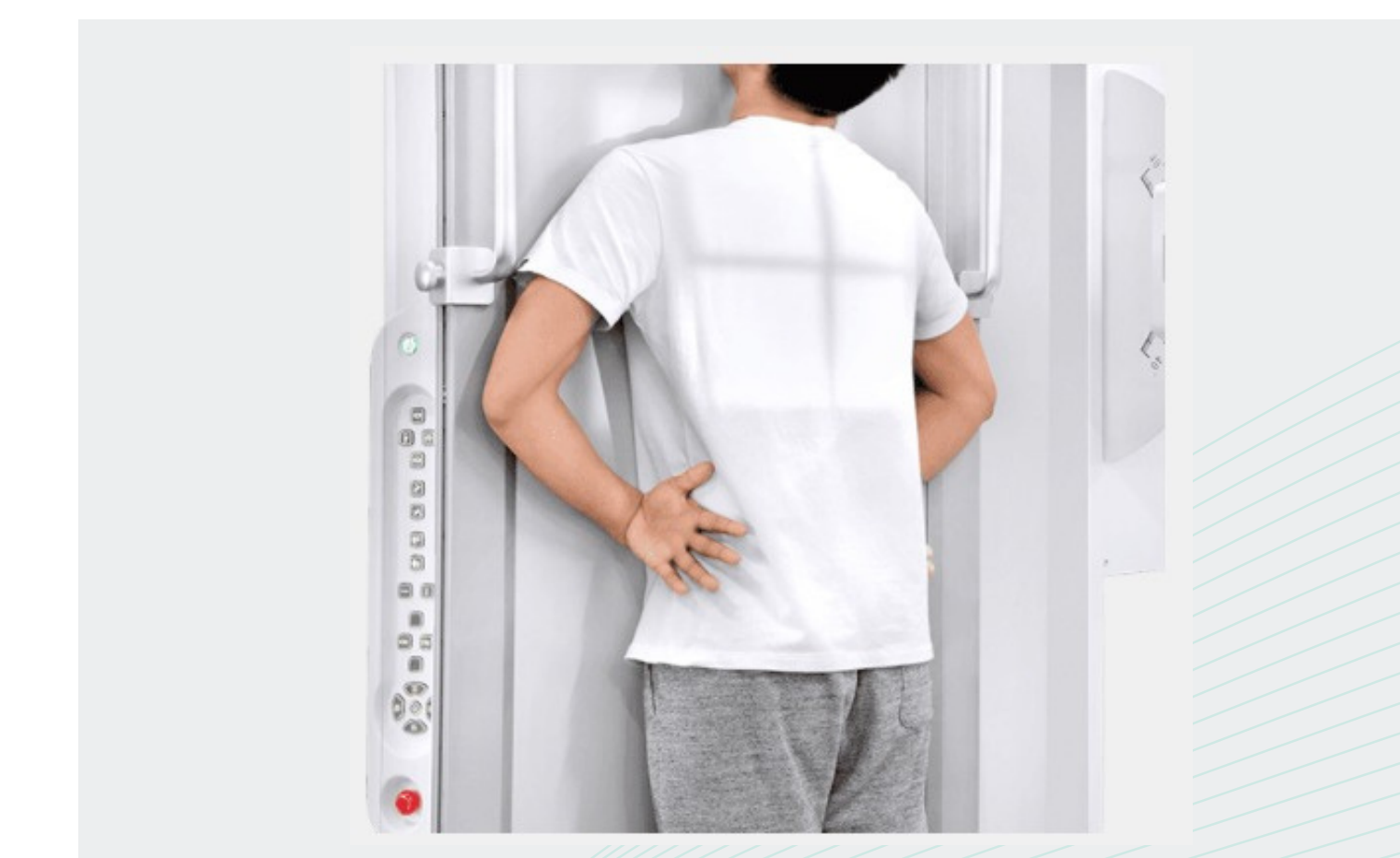

+ Collimator adjusts to different body position

